

Radionica arhitektonskog snimanja sela Vidonje

Nikša Božić, dipl.ing.arh., Marijana Zlodre, mag.ing.arh.,
Ivana Pancirov, dipl.ing.arh., Jurica Zovkić, stud.arh.

APE d.o.o., Zagreb

Radionica **Pilot projekt Vidonje** – radionica arhitektonskog snimanja
Mlinište, 12. srpnja 2019.

KARTOGRAM 1 - zaseoci i sustav naselja Doline Neretve



Pilot projekt – selo Vidonje: radionica arhitektonskog snimanja



Pilot projekt – selo Vidonje: radionica arhitektonskog snimanja

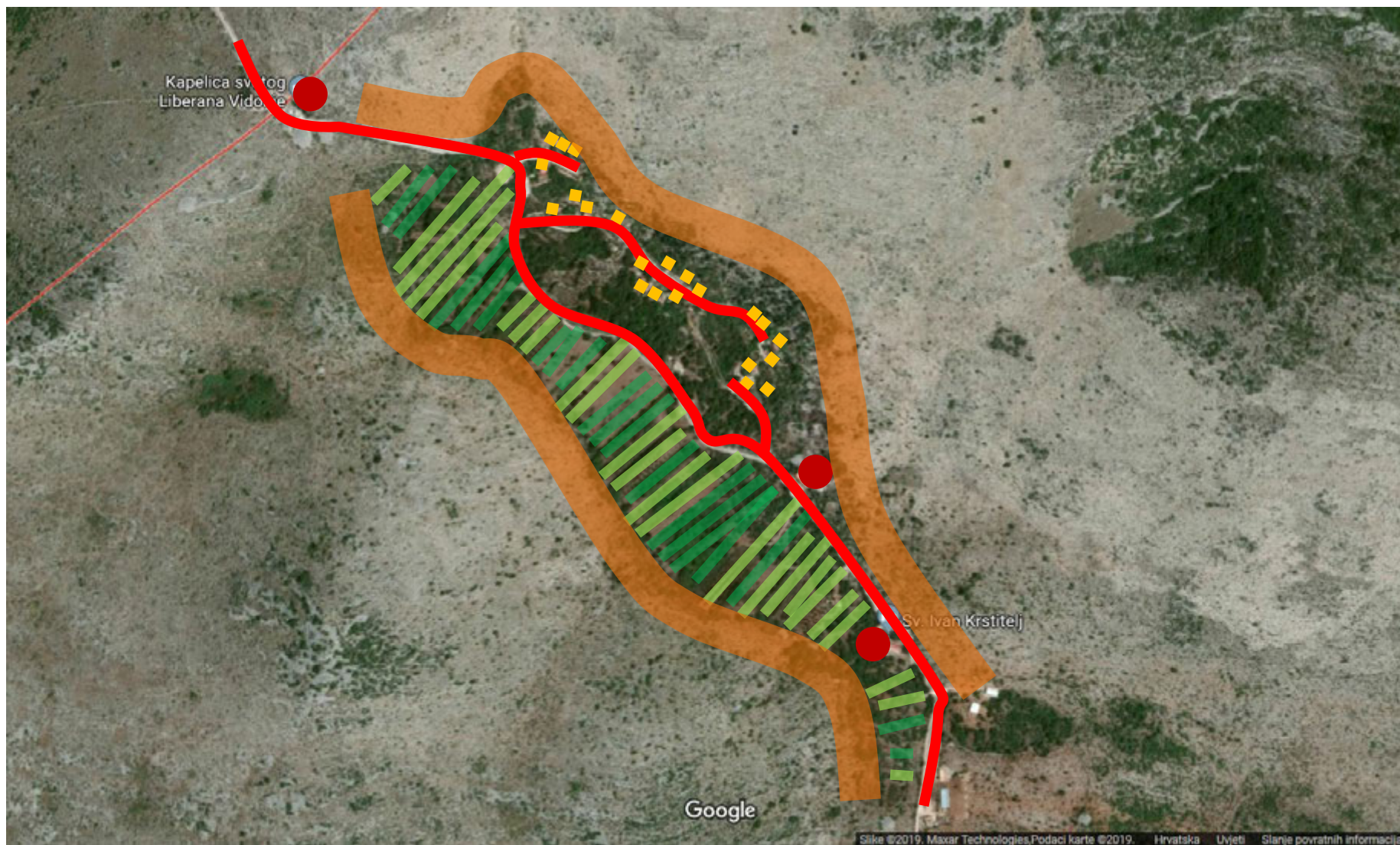



Pilot projekt – selo Vidonje: radionica arhitektonskog snimanja



Pilot projekt – selo Vidonje: radionica arhitektonskog snimanja



Pilot projekt – selo Vidonje: radionica arhitektonskog snimanja



Pilot projekt – selo Vidonje: radionica arhitektonskog snimanja



Pilot projekt – selo Vidonje: radionica arhitektonskog snimanja



Pilot projekt – selo Vidonje: radionica arhitektonskog snimanja



Pilot projekt – selo Vidonje: radionica arhitektonskog snimanja



Pilot projekt – selo Vidonje: radionica arhitektonskog snimanja



Terenski obilazak i fotografsko snimanje:	26.06.2019. Nikša Božić, Marijana Zlodre
Geodetska podloga:	Geodetski ured “Ivić 1/1”, Metković 15.-18.06.2019.
Arhitektonsko snimanje vanjskih dijelova građevina:	1.-4. 07. 2019. Marijana Zlodre, Ivana Pancirov
Nastavak arh. snimanja:	12.07.2019. Marijana Zlodre, Jurica Zovkić

Pilot projekt – selo Vidonje: radionica arhitektonskog snimanja

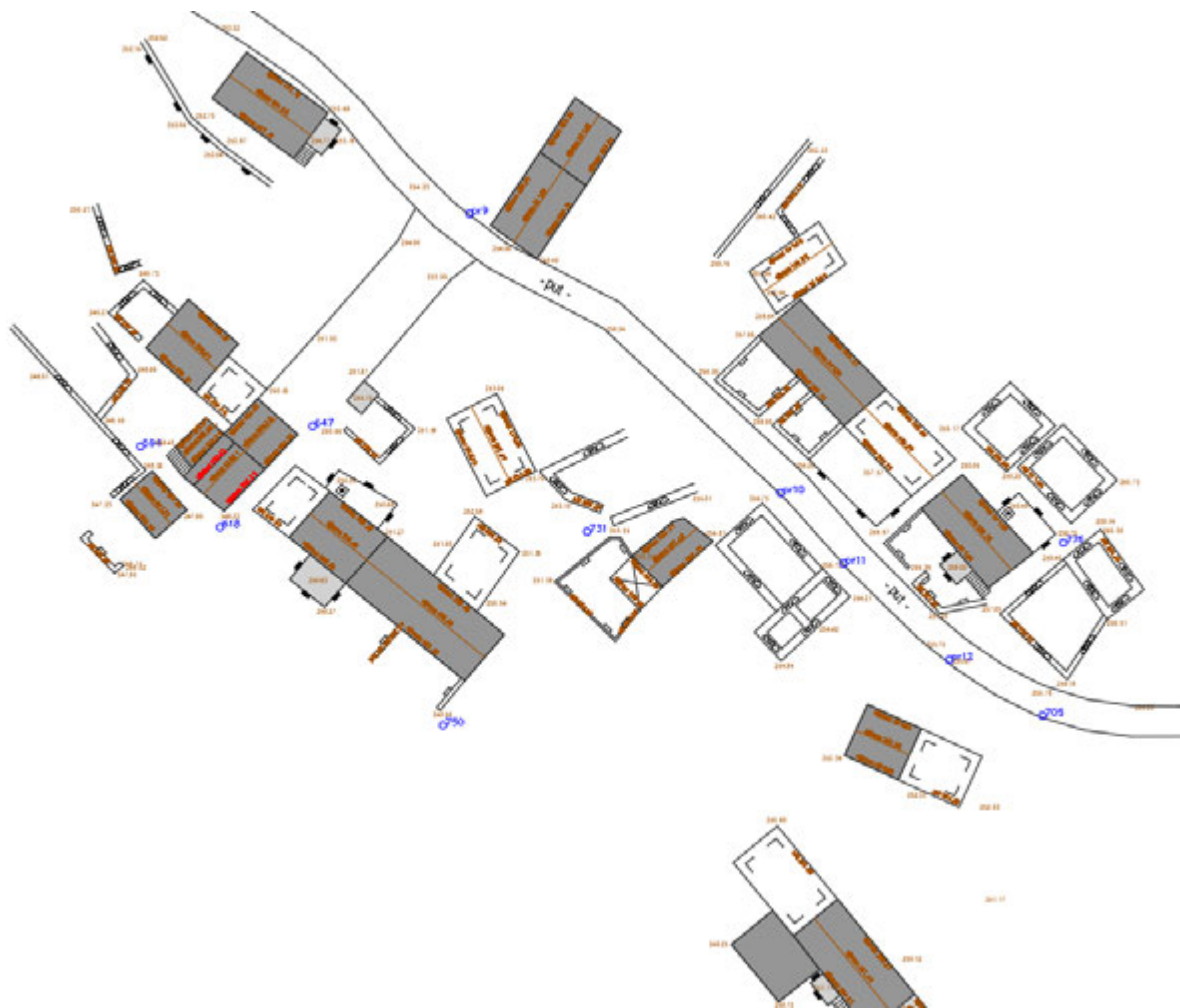

Pilot projekt – selo Vidonje: radionica arhitektonskog snimanja

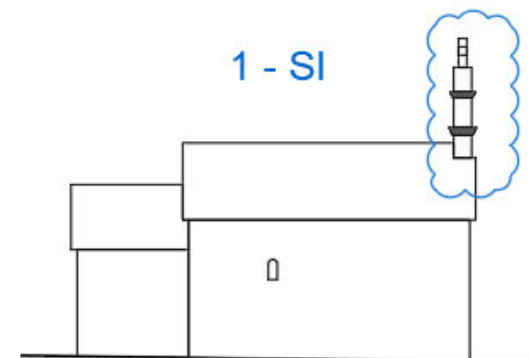
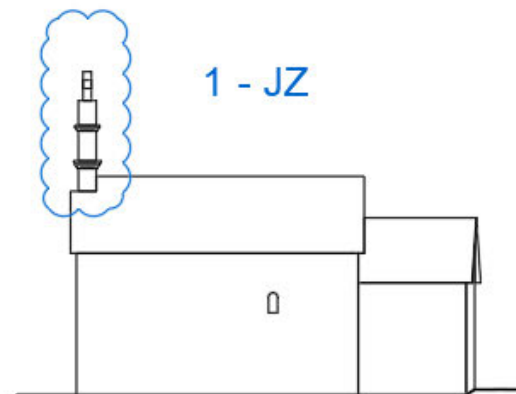
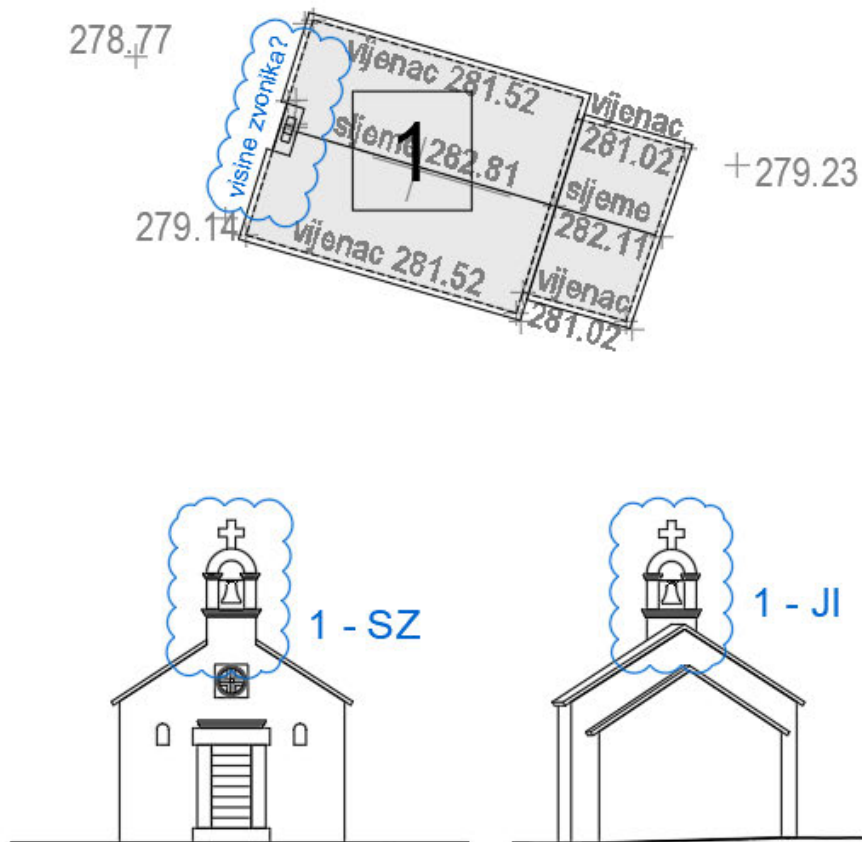

Pilot projekt – selo Vidonje: radionica arhitektonskog snimanja

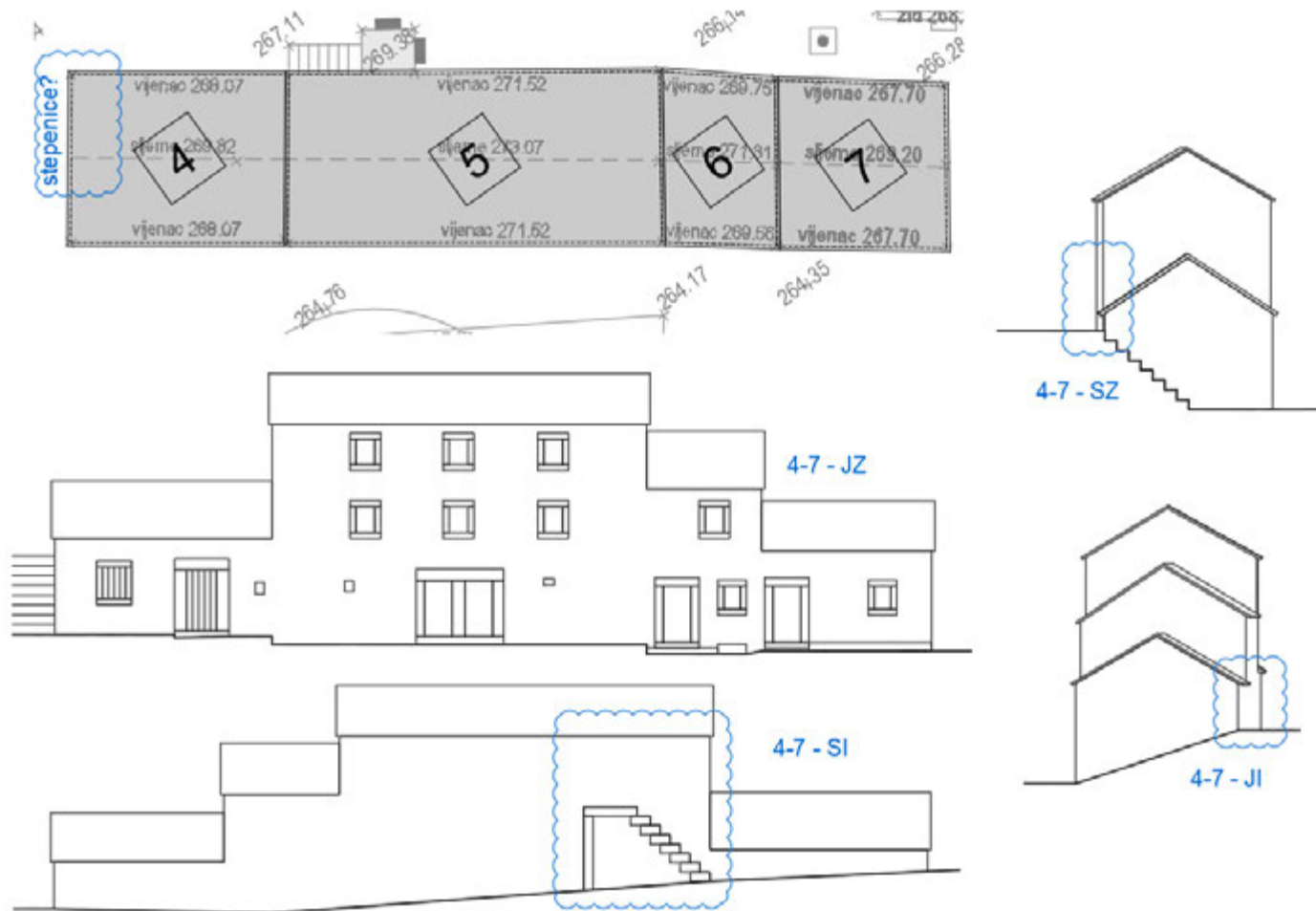

Pilot projekt – selo Vidonje: radionica arhitektonskog snimanja

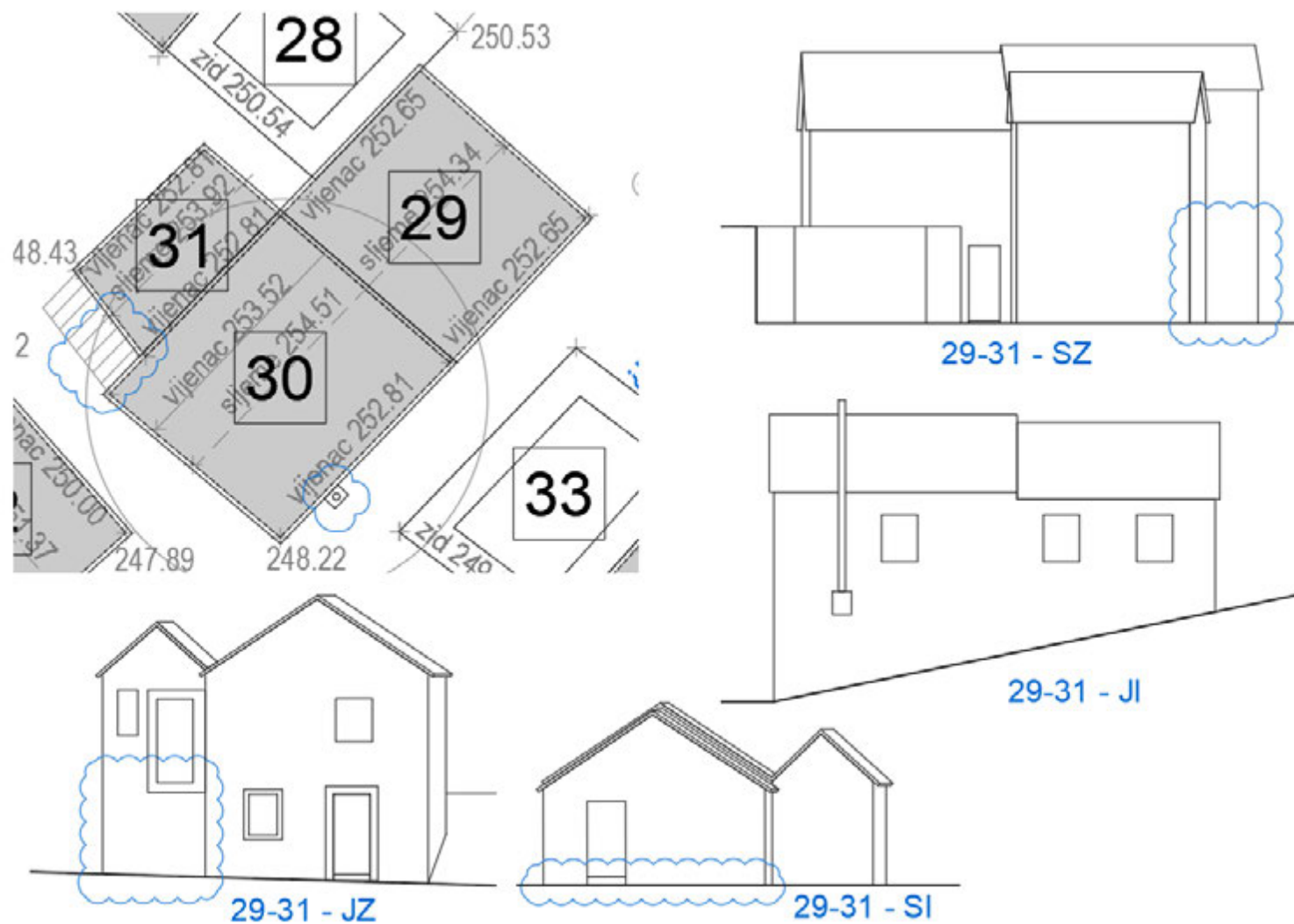



Radionica arhitektonskog snimanja sela Vidonje

Hvala na pažnji

niksa@ape.hr, marijana@ape.hr